

## Medium Single-action Vice Grip, QC fitting



Mec240k - 2.5 kN



Mec240k-S20 - 2 kN



Mec240k-S30 - 1 kN

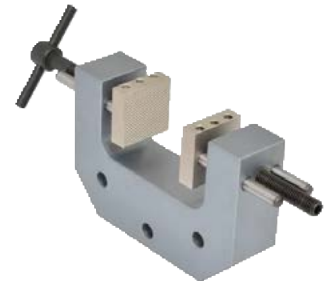

Mec240k-S50 - 1 kN

Mechanical Vice Grips apply a clamping force by manually tightening parallel jaw faces directly onto the specimen. Single-action vice grips allow one jaw to be set in position to align the specimen around the central axis and the other jaw to be freely adjustable to clamp it in place. Consequently they are best suited for tensile testing of symmetrical specimens which do not vary greatly in thickness.

The Mec240k Medium Vice Grips are rated between 1 – 2.5 kN and available in 4 sizes with jaw openings ranging from 0-10mm right up to 0-50mm depending on the jaw types selected. An extensive collection of interchangeable, high-performance jaws with differing surface profiles provide excellent gripping characteristics to ensure that a variety of materials and components can be securely held.

Ideal for tension tests below 2.5kN on flat strips of metal and plastic, thin sheets and tapes plus non-woven and general fabrics.

Item No:	Mec240k	Mec240k-S20	Mec240k-S30	Mec240k-S50
Rated capacity:	2.5 kN	2 kN	1 kN	1 kN
Opening (depending on jaws):	0-10mm	0-20mm	0 – 30mm	0-50mm
Weight each grip(without jaws):	0.27 kg	0.32kg	0.33 kg	0.54 kg

Scope of delivery: 1 grip supplied fitted with bore-hole to allow connection to QC-20 fixing post

**Note:** Jaws (see table below) must be ordered separately.  
Scope of delivery 0.5 set = 2 jaws (left & right). Order any combination of 2 half-sets of jaws to fit into a pair of any Mec240k Medium Vice grips (upper & lower)

Item no.	Surface	Clamping surface H x W	Opening for Mec240k	Opening for Mec240k-S20	Opening for Mec240k-S30	Opening for Mec240k-S50	Weight per 0.5 set
Mec240k-B	Blank jaws	30 x 30 mm	0 – 10 mm	0 -020 mm	0 – 30 mm	∅ – 52 mm	0.13 kg
Mec240k-BG	Rubber jaws	30 x 30 mm	0 – 8 mm	0 -018 mm	0 – 28 mm	∅ – 50 mm	0.13 kg
Mec240k-BP	Pyramid jaws	30 x 30 mm	0 – 10 mm	0 -020 mm	0 – 30 mm	∅ – 52 mm	0.12 kg
Mec240k-BV2	V jaws	30 x 30 mm	∅ 2 – 10 mm	∅ 20 mm	∅ 2- 30 mm	∅ 2 – 52 mm	0.12 kg
Mec240k-BV3	V jaws	30 x 30 mm	∅ 3 – 10 mm	∅ 20 mm	∅ 3 - 30 mm	∅ 3 – 52 mm	0.13 kg
Mec240k-BW	Wave jaws	30 x 30 mm	0 – 10 mm	0 -020 mm	0 – 30 mm	∅ – 52 mm	0.12 kg
Mec240k-BD	Diamond jaws	30 x 30 mm	0 – 10 mm	0 -020 mm	0 – 30 mm	∅ – 52 mm	0.13 kg
Mec240k-B50	Blank jaws	30 x 50 mm	0 – 10 mm	0 -020 mm	0 – 30 mm	∅ – 52 mm	0.22 kg
Mec240k-BG50	Rubber jaws	30 x 50 mm	0 – 8 mm	0 -018 mm	0 – 28 mm	∅ – 50 mm	0.23 kg
Mec240k-BP50	Pyramid jaws	30 x 50 mm	0 – 10 mm	0 -020 mm	0 – 30 mm	∅ – 52 mm	0.21 kg
Mec240k-BW50	Wave jaws	30 x 50 mm	0 – 10 mm	0 -020 mm	0 – 30 mm	∅ – 52 mm	0.20 kg
Mec240k-BD50	Diamond jaws	30 x 50 mm	0 – 10 mm	0 -020 mm	0 – 30 mm	∅ – 52 mm	0.22 kg
Mec240k-B80	Blank jaws	30 x 80 mm	0 – 10 mm	0 -020 mm	0 – 30 mm	∅ – 52 mm	0.36 kg
Mec240k-BG80	Rubber jaws	30 x 80 mm	0 – 8 mm	0 -018 mm	0 – 28 mm	∅ – 50 mm	0.37 kg
Mec240k-BP80	Pyramid jaws	30 x 80 mm	0 – 10 mm	0 -020 mm	0 – 30 mm	∅ – 52 mm	0.35 kg
Mec240k-BW80	Wave jaws	30 x 80 mm	0 – 10 mm	0 -020 mm	0 – 30 mm	∅ – 52 mm	0.32 kg
Mec240k-BD80	Diamond jaws	30 x 80 mm	0 – 10 mm	0 -020 mm	0 – 30 mm	∅ – 52 mm	0.36 kg
Mec240k-B100	Blank jaws	30 x 100 mm	0 – 10 mm	0 -020 mm	0 – 30 mm	∅ – 52 mm	0.45 kg
Mec240k-BG100	Rubber jaws	30 x 100 mm	0 – 8 mm	0 -018 mm	0 – 28 mm	∅ – 50 mm	0.46 kg
Mec240k-BP100	Pyramid jaws	30 x 100 mm	0 – 10 mm	0 -020 mm	0 – 30 mm	∅ – 52 mm	0.45 kg
Mec240k-BW100	Wave jaws	30 x 100 mm	0 – 10 mm	0 -020 mm	0 – 30 mm	∅ – 52 mm	0.51 kg
Mec240k-BD100	Diamond jaws	30 x 100 mm	0 – 10 mm	0 -020 mm	0 – 30 mm	∅ – 50 mm	0.45 kg

Jaws with other dimensions and surface coatings on request

	<b>Blank jaws</b> - Applicable for own further treatments - Steel-blanks without coating
	<b>Rubber jaws</b> - 1mm rubber coating (NBR) - Nickel plated
	<b>Pyramid jaws</b> - Pyramids 1.2x45° - Hardened steel 58 HRC - Nickel plated
	<b>V-jaws</b> - For all kinds of round samples - Tooth pitch 1.2 mm - Hardened steel 58HRC - Nickel plated
	<b>Wavejaws</b> - For flexible materials - Wave 5 mm - Hardened steel 58HRC - Nickel plated
	<b>Diamondjaws</b> - Clamping surface coated with synthetic diamonds D91 (170/200 mesh) - Nickel plated



Mec240k-BV2

Mec240k-BV3

## Dimensions mm

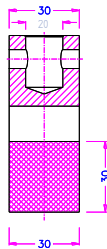
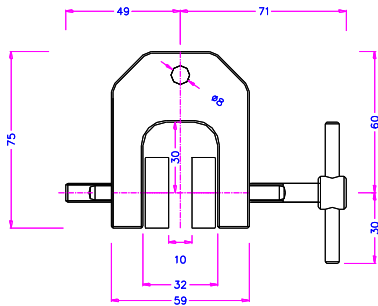

Mec240k

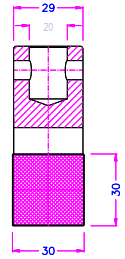
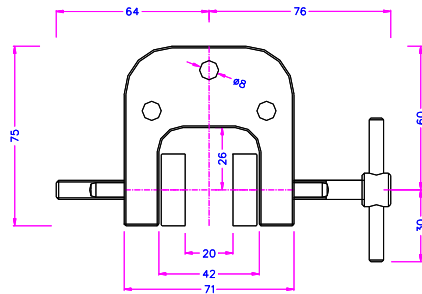

Mec240k-S20

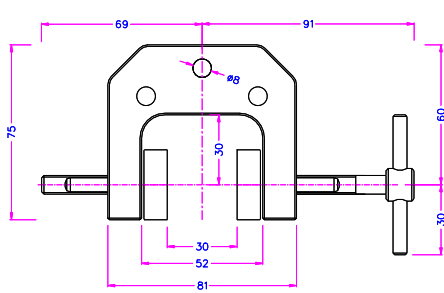

Mec240k-S30

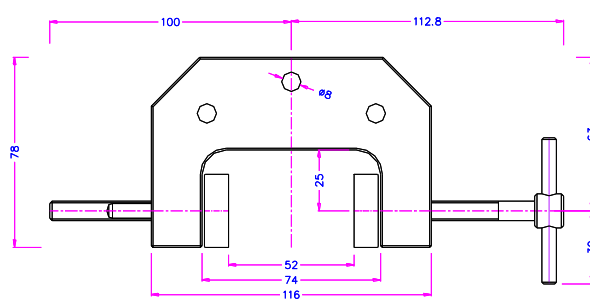
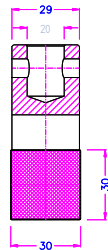

Mec240k-S50

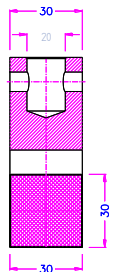

FS 58553

Mecmesin reserves the right to alter equipment specifications without prior notice.

E&OE

DISTRIBUTOR STAMP

**Head Office - UK**  
Mecmesin Limited

w: [www.mecmesin.com](http://www.mecmesin.com)  
e: [sales@mecmesin.com](mailto:sales@mecmesin.com)

**North America**  
Mecmesin Corporation

w: [www.mecmesincorp.com](http://www.mecmesincorp.com)  
e: [info@mecmesincorp.com](mailto:info@mecmesincorp.com)

**France**  
Mecmesin France

w: [www.mecmesin.fr](http://www.mecmesin.fr)  
e: [contact@mecmesin.fr](mailto:contact@mecmesin.fr)

**Asia**  
Mecmesin Asia Co., Ltd

w: [www.mecmesinasia.com](http://www.mecmesinasia.com)  
e: [sales@mecmesinasia.com](mailto:sales@mecmesinasia.com)

**Germany**  
Mecmesin GmbH

w: [www.mecmesin.de](http://www.mecmesin.de)  
e: [info@mecmesin.de](mailto:info@mecmesin.de)

**China**  
Mecmesin (Shanghai) Pte Ltd

w: [www.mecmesin.cn](http://www.mecmesin.cn)  
e: [sales@mecmesin.cn](mailto:sales@mecmesin.cn)